

Yaskawa
CIMR-AD4A011AMA
7.5 kw / 10HP

- (H3-02) Multi-Function Analog Input 1
-10 to +10VDC, 20k ohm
- (H3-10) Multi-Function Analog Input 2
-10 to +10VDC, 20k ohm (S1 V)
- (H3-06) Multi-Function Analog Input 3/PTC Input
-10 to +10VDC, 20k ohm (S4 A)
- (H6-01) Multi-Function Pulse Input
0 to 32kHz, 5 to 12VDC, 3k ohm

NOTE

1. SCHEMATICS SHOWN IS SUITABLE FOR BI-DIRECTIONAL OPERATION OF MOTORS
2. CONTROL SUPPLY VOLTAGE IS SINGLE PHASE 240V AC
3. THE AMMETER SHALL BE DIGITAL TYPE

TENDER PURPOSE ONLY

CINE :	VISAKHAPATNAM PORT LOGISTICS PARK LIMITED. (A BALMER LAWRIE - VISAKHAPATNAM PORT TRUST JV)
PROJECT :	PROPOSED MULTI MODAL LOGISTICS HUB AT VIZAG
TITLE :	POWER CKT FOR VFD STARTER
CONSULTANTS :	 aarvee associates architects engineers & consultants pvt.ltd. Ravula Residency, Srinagar Colony Main Rd., Hyderabad-82, India Tel: +91-40-23737633; Fax: +91-40-23736277 e-mail: railways@aarvee.net; web: www.aarvee.net
DRG.NO. AA / Rly / 1691 / BL&CL / POW CKT - VFD STR	
SCALE : NTS	
SHEET No. 1/1	Rev.No.
ISSUED Dt : 02-01-2017	Rev Dt:

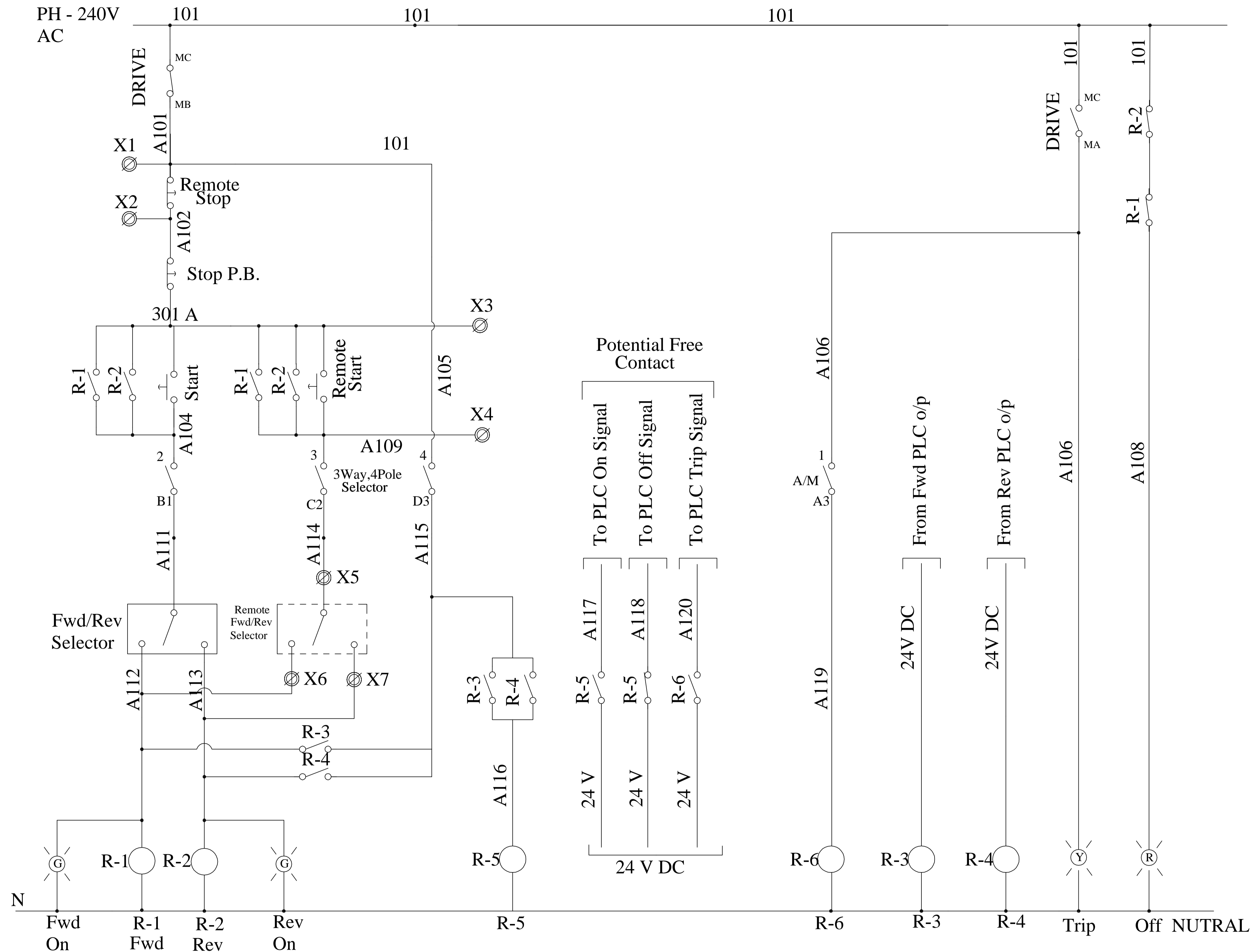

NOTE

1. SCHEMATICS SHOWN IS SUITABLE FOR BI-DIRECTIONAL OPERATION OF MOTORS
2. CONTROL SUPPLY VOLTAGE IS SINGLE PHASE 240V AC
3. THE AMMETER SHALL BE DIGITAL TYPE

TENDER PURPOSE ONLY

CINE :	VISAKHAPATNAM PORT LOGISTICS PARK LIMITED. (A BALMER LAWRIE - VISAKHAPATNAM PORT TRUST JV)	
PROJECT :	PROPOSED MULTI MODAL LOGISTICS HUB AT VIZAG	
TITLE :	CONTROL CKT FOR VFD STARTER	
CONSULTANTS :	 aarvee associates architects engineers consultants pvt.ltd. Ravula Residency, Srinagar Colony Main Rd., Hyderabad-82, India Tel: +91-40-23737633; Fax: +91-40-23736277 e-mail: railways@aarvee.net; web: www.aarvee.net	
DRG.NO. AA / Rly / 1691 / BL&CL / CONT CKT-VFD STR		
SCALE : NTS		
SHEET No. 1/1	Rev.No.	
ISSUED Dt: 02-01-2017	Rev Dt:	

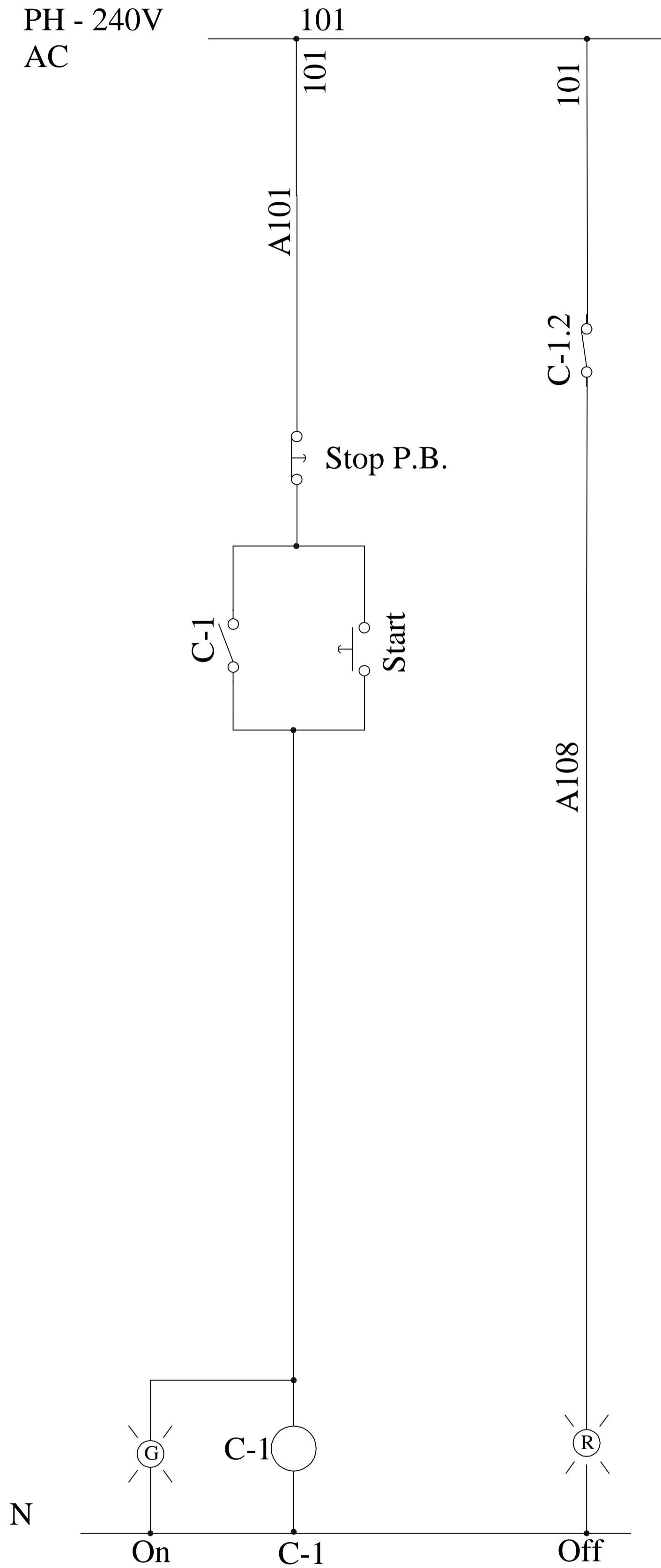
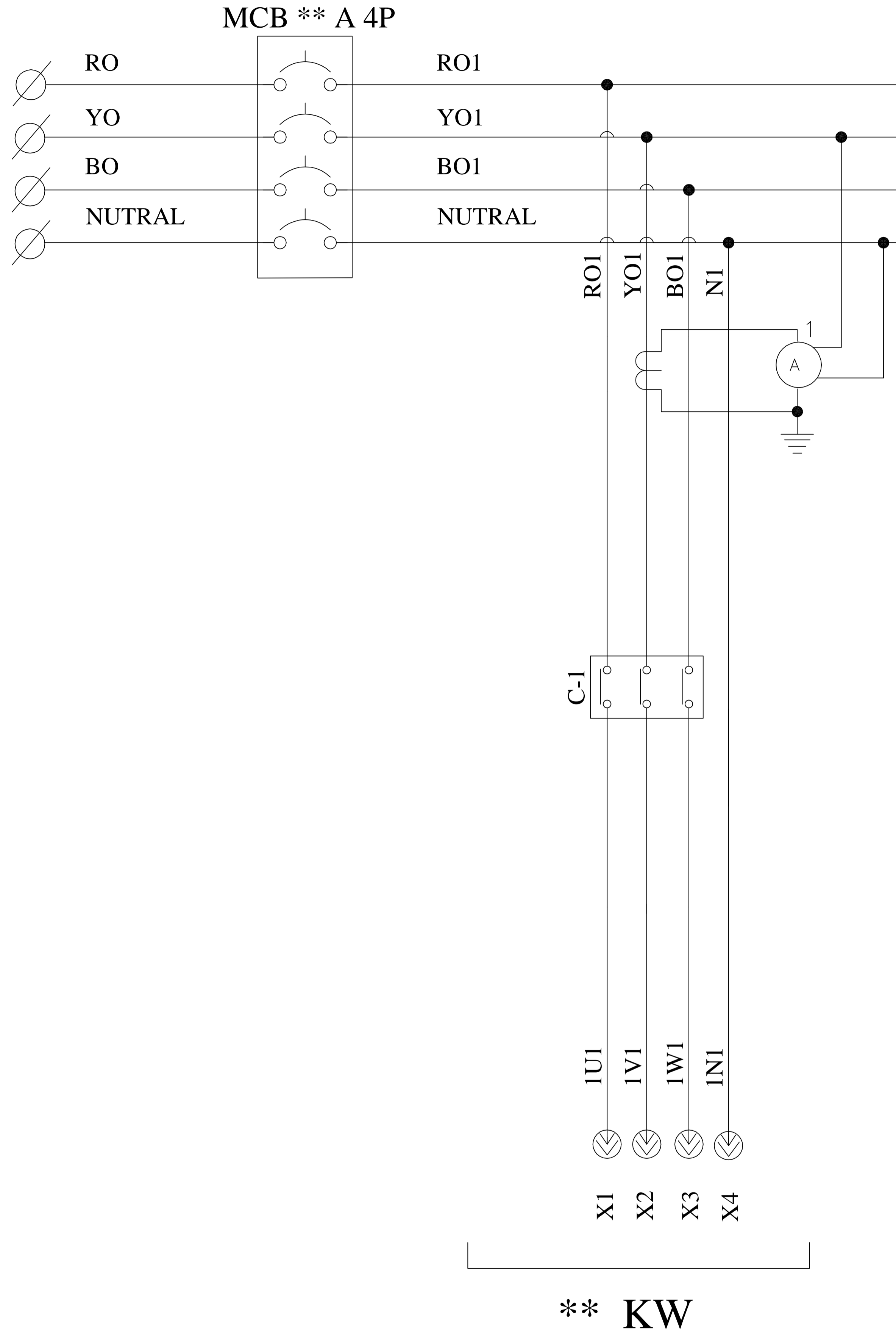

- NOTE**
1. SCHEMATICS SHOWN IS SUITABLE FOR OUTGOING POWER FEEDERS
 2. CONTROL SUPPLY VOLTAGE IS SINGLE PHASE 240V AC
 3. THE AMMETER SHALL BE DIGITAL TYPE

CINE :	VISAKHAPATNAM PORT LOGISTICS PARK LIMITED. (A BALMER LAWRIE - VISAKHAPATNAM PORT TRUST JV)
PROJECT :	PROPOSED MULTI MODAL LOGISTICS HUB AT VIZAG
TITLE :	POWER & CONT. CKT FOR GENERAL OUTGOING FEEDER
CONSULTANTS :	 aarvee associates architects engineers & consultants pvt.ltd. Ravula Residency, Srinagar Colony Main Rd., Hyderabad-82, India Tel: +91-40-23737633; Fax: +91-40-23736277 e-mail: railways@aarvee.net; web: www.aarvee.net
DRG.NO. AA / Rly / 1691 / BL&CL / POW & CONT. CKT - GOF	
SCALE : NTS	
SHEET No. 1/9	Rev.No.
ISSUED Dt : 02-01-2017	Rev Dt:

TENDER PURPOSE ONLY

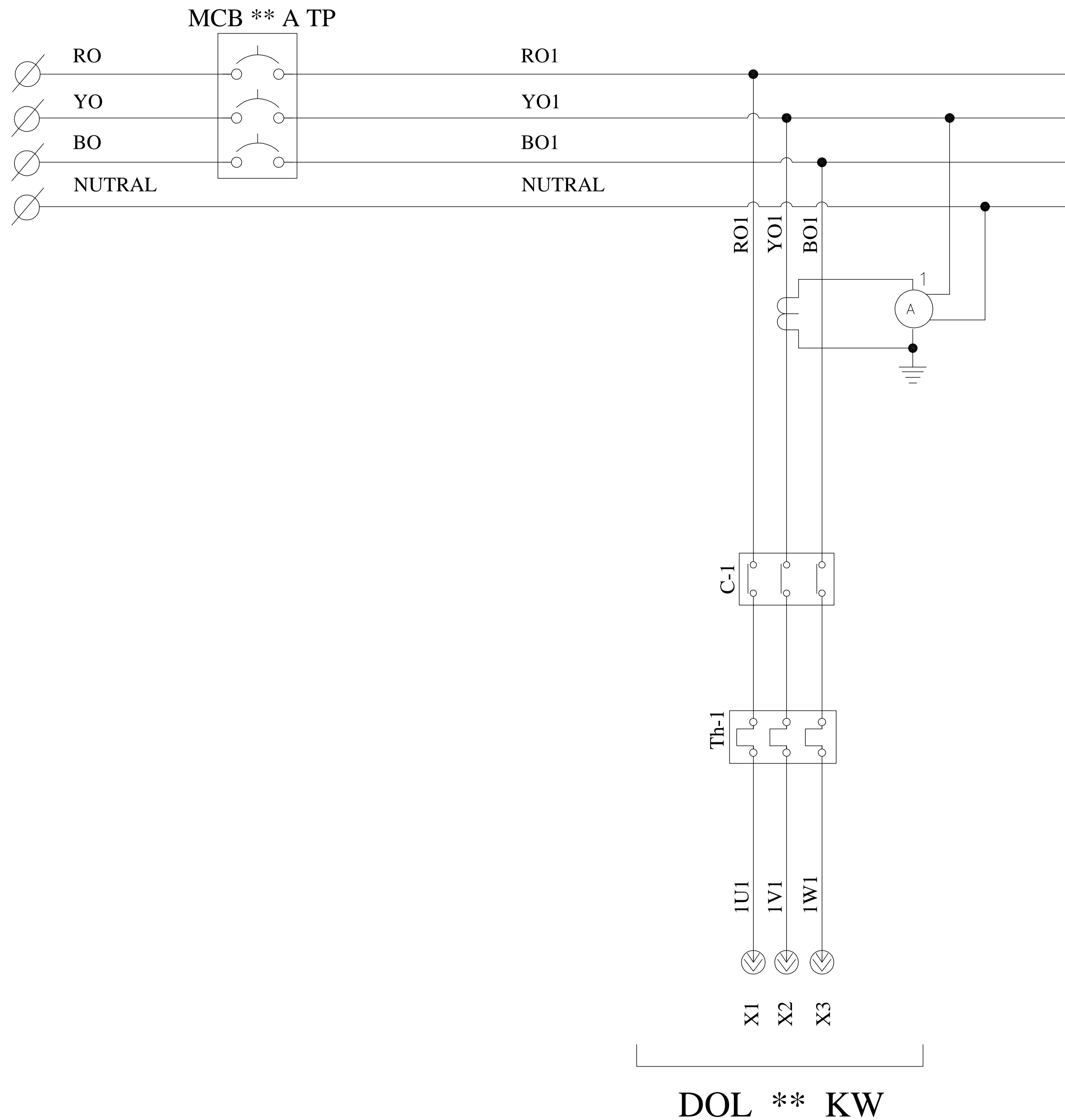

DOL ** KW

TENDER PURPOSE ONLY

NOTE

1. SCHEMATICS SHOWN IS SUITABLE FOR UNI-DIRECTIONAL OPERATION OF MOTORS
2. CONTROL SUPPLY VOLTAGE IS SINGLE PHASE 240V AC
3. THE AMMETER SHALL BE DIGITAL TYPE

CINE :	<i>VISAKHAPATNAM PORT LOGISTICS PARK LIMITED. (A BALMER LAWRIE - VISAKHAPATNAM PORT TRUST JV)</i>	
PROJECT :	<i>PROPOSED MULTI MODAL LOGISTICS HUB AT VIZAG</i>	
TITLE :	POWER CKT FOR UNI-DIRECTIONAL DOL STARTER	
CONSULTANTS :	 aarvee associates architects,engineers&consultants pvt.ltd. Ravula Residency, Srinagar Colony Main Rd., Hyderabad-82, India Tel: +91-40-23737633; Fax: +91-40-23736277 e-mail: railways@aarvee.net; web: www.aarvee.net	
DRG.NO. AA / Rly / 1691 / BL&CL / POW. CKT-UDDS		
SCALE : NTS		
SHEET No. 1/1	Rev.No.	
ISSUED Dt : 02-01-2017	Rev Dt:	

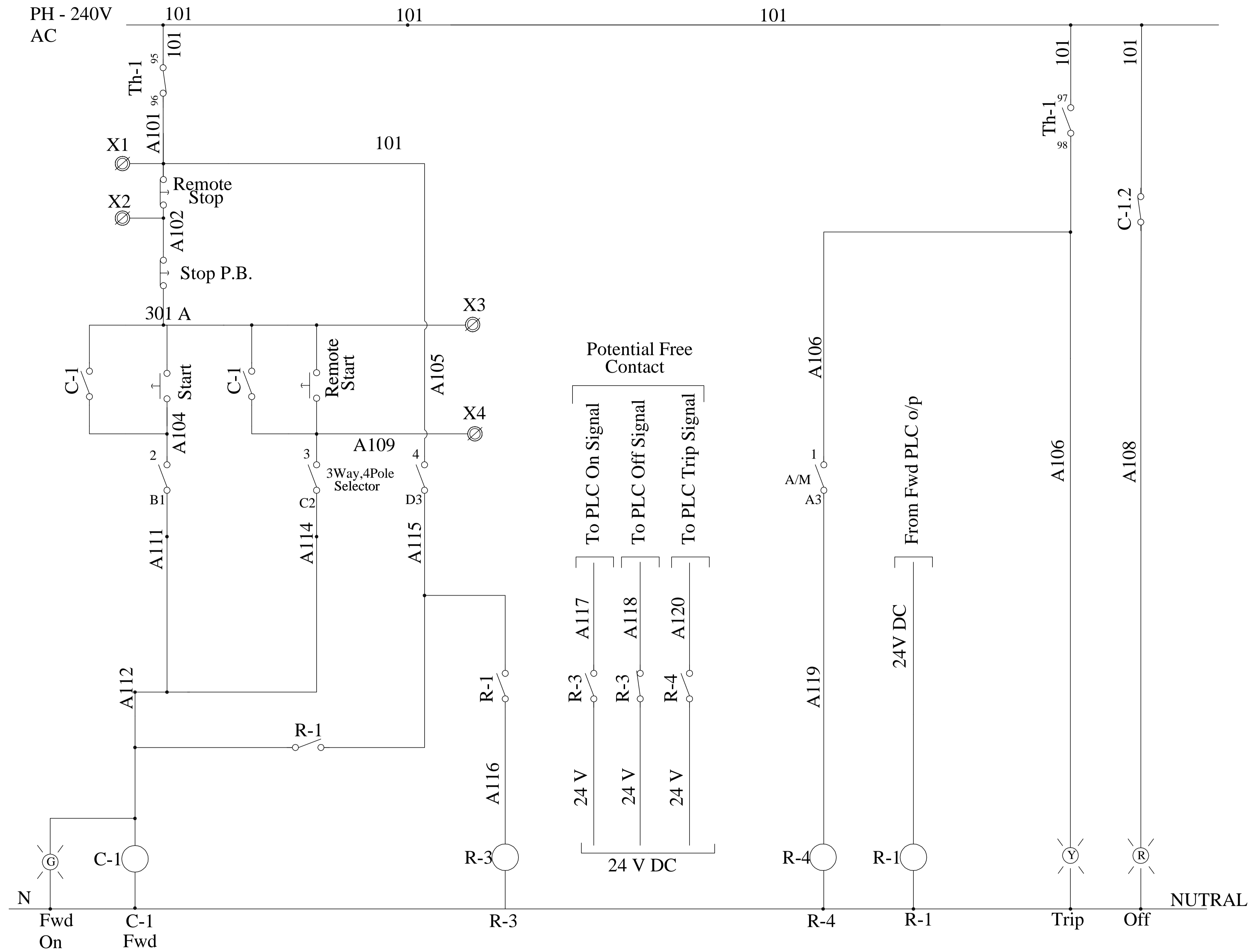

- NOTE**
1. SCHEMATICS SHOWN IS SUITABLE FOR UNI-DIRECTIONAL OPERATION OF MOTORS
 2. CONTROL SUPPLY VOLTAGE IS SINGLE PHASE 240V AC
 3. THE AMMETER SHALL BE DIGITAL TYPE

CINE :	VISAKHAPATNAM PORT LOGISTICS PARK LIMITED. (A BALMER LAWRIE - VISAKHAPATNAM PORT TRUST JV)	
PROJECT :	PROPOSED MULTI MODAL LOGISTICS HUB AT VIZAG	
TITLE :	CONTROL CKT FOR UNI-DIRECTIONAL DOL STARTER	
CONSULTANTS :	 aarvee associates architects engineers & consultants pvt.ltd. Ravula Residency, Srinagar Colony Main Rd., Hyderabad-82, India Tel: +91-40-23737633; Fax: +91-40-23736277 e-mail: railways@aarvee.net; web: www.aarvee.net	
DRG.NO. AA / Rly / 1691 / BL&CL / CONT. CKT-UDDS		
SCALE : NTS		
SHEET No. 1/1	Rev.No.	
ISSUED Dt : 02-01-2017	Rev Dt:	

TENDER PURPOSE ONLY

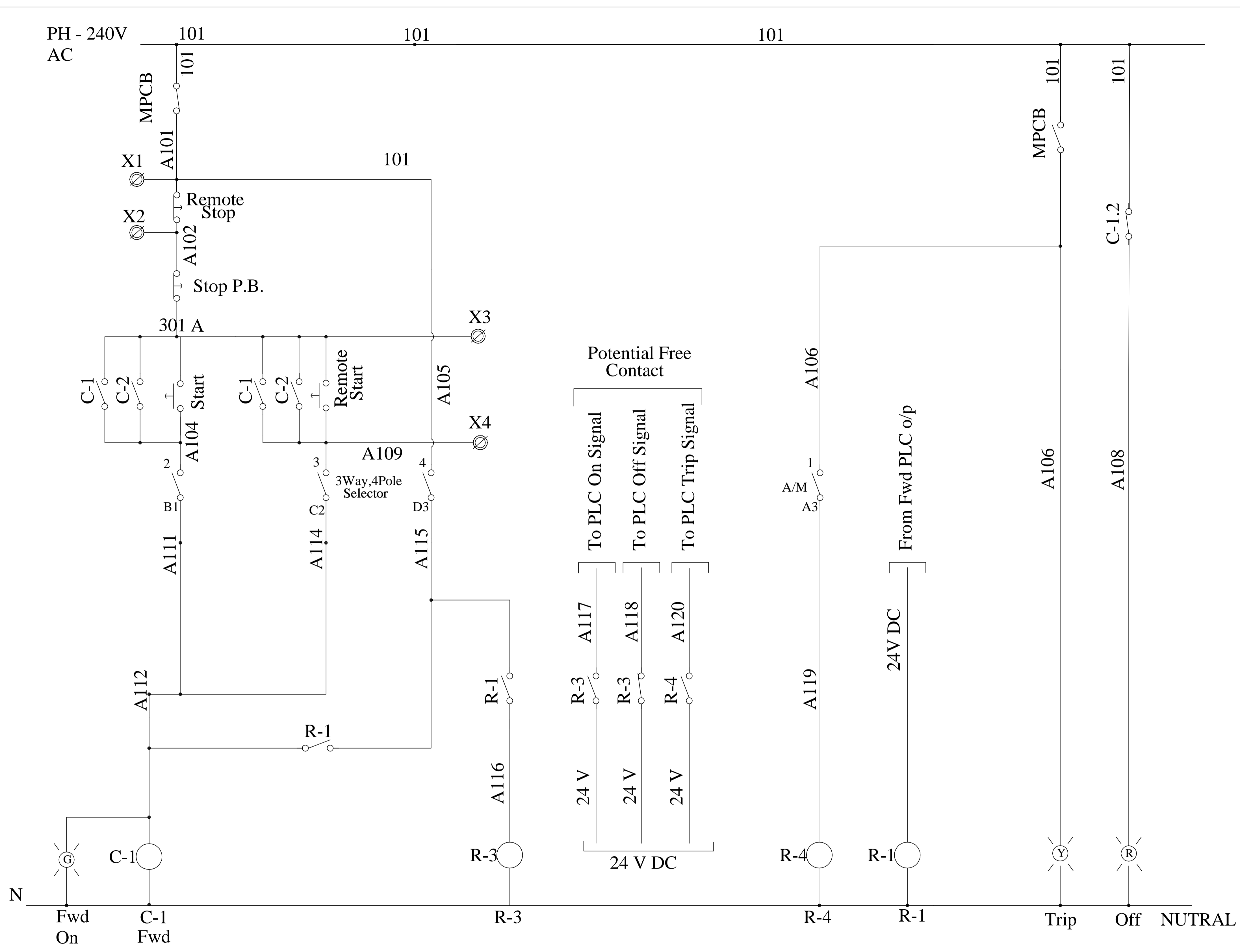

- NOTE**
1. SCHEMATICS SHOWN IS SUITABLE FOR UNI-DIRECTIONAL OPERATION OF MOTORS
 2. CONTROL SUPPLY VOLTAGE IS SINGLE PHASE 240V AC
 3. THE AMMETER SHALL BE DIGITAL TYPE

CINE : VISAKHAPATNAM PORT LOGISTICS PARK LIMITED. (A BALMER LAWRIE - VISAKHAPATNAM PORT TRUST JV)	
PROJECT : PROPOSED MULTI MODAL LOGISTICS HUB AT VIZAG	
TITLE : CONTROL CKT FOR UNI-DIRECTIONAL MPCB STARTER	
CONSULTANTS : <div style="text-align: center;">  aarvee associates <small>architects engineers & consultants pvt.ltd.</small> <small>Ravula Residency, Srinagar Colony Main Rd., Hyderabad-82, India</small> <small>Tel: +91-40-23737633; Fax: +91-40-23736277</small> <small>e-mail: railways@aarvee.net; web: www.aarvee.net</small> </div>	
DRG.NO. AA / Rly / 1691 / BL&CL / CONT. CKT - UD MPCB STR.	
SCALE : NTS	
SHEET No. 1/1	Rev.No.
ISSUED Dt : 02-01-2017	Rev Dt:

TENDER PURPOSE ONLY